

1 2 3 4 5 6 7 8

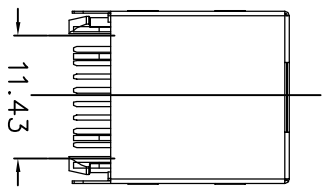

PC BOARD CONNECTIONS

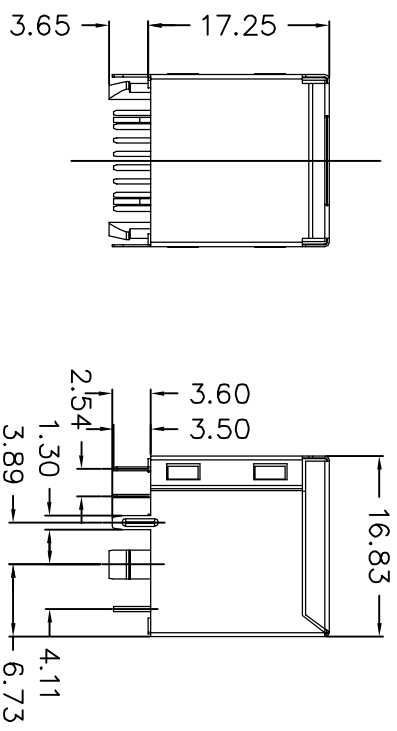
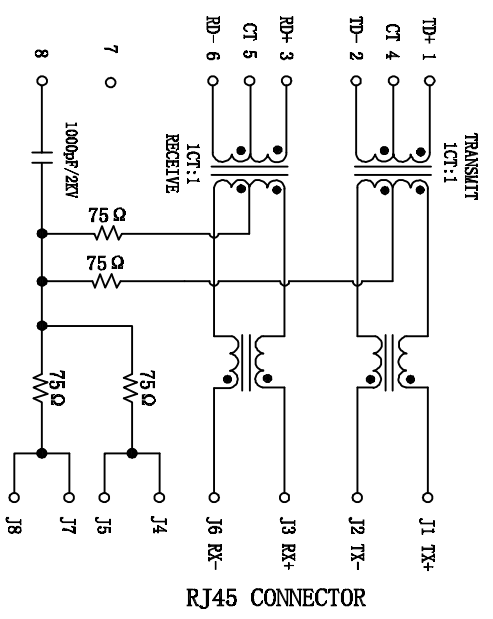

RJ45 CONNECTOR

GREEN

YELLOW

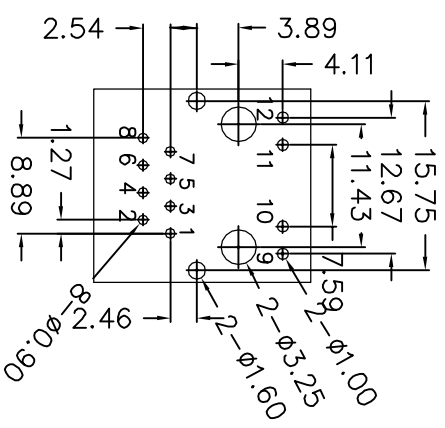
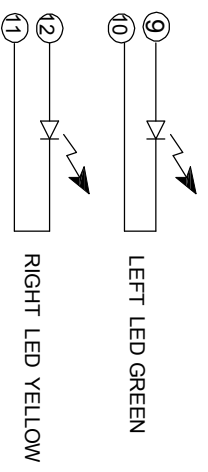
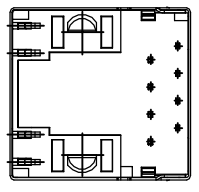
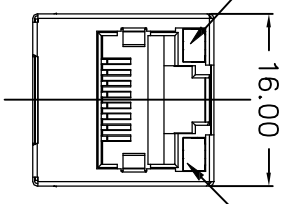

PCB LAYOUT

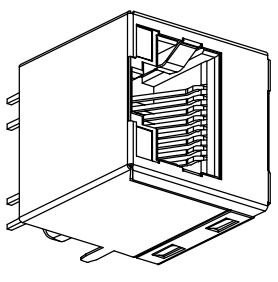

Specification LED

Standard LED Color	LED Wavelength (or WLD)	Forward (V MAX)	Typical (V TYP)	Luminous Intensity
Green	560-580 nm	2.5V	2.1-2.2V	9-25 MCD
Yellow	580-610 nm	2.5V	2.1-2.2V	9-30 MCD

CSCONN

PART NO. (INTENDED USE)
CRJ08171602003

CSCONN PRECISE ELECTRONICS CO.,LTD

TITLE: RJ45 8P DIP180 10/100BASE LBD

DWG NO. RJ45

APPD:
CHKD: SKILIA

DR: Kitty



SCALE 1:1
SHEET 1 OF 1
REV A

E

D

C

B

A

E

D

C

B

A